



# AT 500 ALUMINIUM-HAUSEINGANGSTÜR



## EIGENSCHAFTEN

	<b>Wärmedämmung</b>	bis $U_b = 0,91 \text{ W/(m}^2\text{K)}$
	<b>Schallschutz</b>	bis 40 dB
	<b>Sicherheit</b>	bis RC3
	<b>Verriegelung</b>	Mehrfach-Verriegelung
	<b>Bautiefe</b>	93 mm

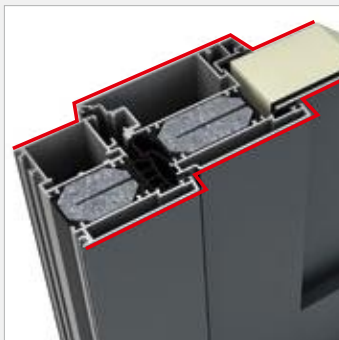

Innen und Außen profiliert



Füllungsaufbau mit Dehneinlage für ausgezeichnete Klimastabilität

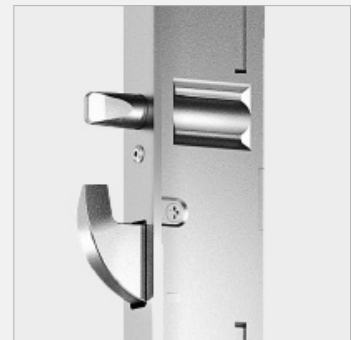

5-fach Verriegelung im Standard für höchste Sicherheit

Schnitte

Schnitt unten

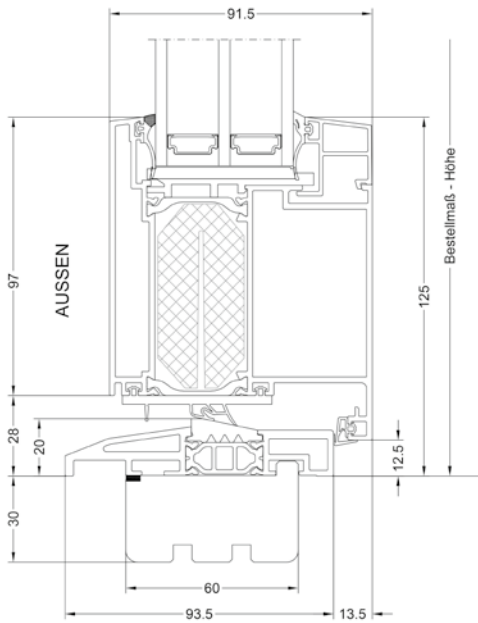

Schnitt seitlich, oben

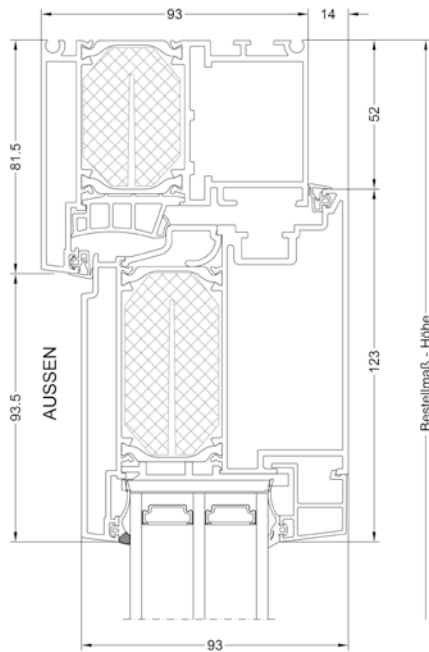

**SJ**  
Bestellnr: S0004



**AM**  
Bestellnr: A0007



**SL**



**AJ**  
Bestellnr: A0006

Weitere Modelle finden Sie im Türendesigner:

